

Your Partner For Factory-direct Windows & Doors

Made In USA Certified



RJT industries

manufacturing quality windows for over 40 years

Gold Series Windows



Featuring The Best Warranty In The Industry

Our **Gold Series Windows** are designed to provide the ultimate strength while giving homeowners aesthetic quality, energy efficiency and security. Backed by the **Good Housekeeping Seal**, Earthwise Windows are built to last and engineered to provide excellent thermal performance for as long as you own your home.

Limited lifetime coverage on:

Accidental glass breakage

Seal failure

All hardware

Vinyl frame & sash components

Coverage is:

Fully transferable

Non-prorated

Warranty:

backed by
40 years of quality window manufacturing



Unlimited Styles

Whether trying to preserve a certain architectural look or create a dramatic statement, we offer a multitude of combinations utilizing styles, shapes and sizes that can fit your needs.

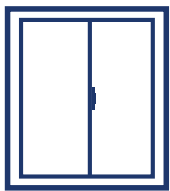

Slider



Double Hung

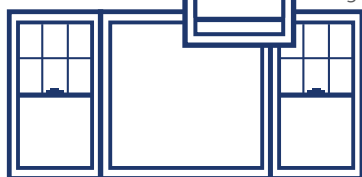

Quarter/Half/Quarter



Casement

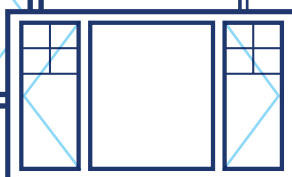

Quarter/Half/Quarter



Picture



Trapezoid

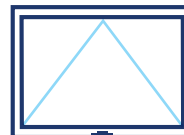

Awning

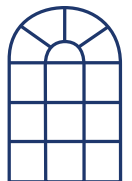

Palladium

Architectural Design



Bay, Bow, & Garden

Manufacturing Details That Matter

You can trust our team to make sure every small detail is covered. Quality features you should expect from a great window as well as superior design elements make our windows a permanent solution. And, with all of these attributes, the need for service is virtually eliminated.

Our Windows Guarantee Efficiency And Strength

Backed by the Good Housekeeping Seal

Gold Features:

Heavy-walled construction

Builds in more durability.

Secure Vent Latch

Allows for ventilation with added security deterrent benefits.

Fusion-Welded Frame & Sash

Provides strength, durability, and perfectly square windows that are air tight.

Dual Tilt-In Sashes

Sashes tilt in for easy cleaning due to safety tilt hardware.

Interlocking Meeting Rail

Integral interlock provides additional security and draft-sealing efficiencies.

Equal Glass Sizes

Provides traditional architecture look with superior structural integrity.

Sunshield® PVC Chemistry

Specially formulated by Deceuninck to perform well in extreme weather conditions.

Dual Action Swing Lock System

Offers superior security deterrent.

Strong One-piece Sloped Sill

Multi-cavity sloped sill has no snap-on parts and provides positive water runoff, even in driving rain.

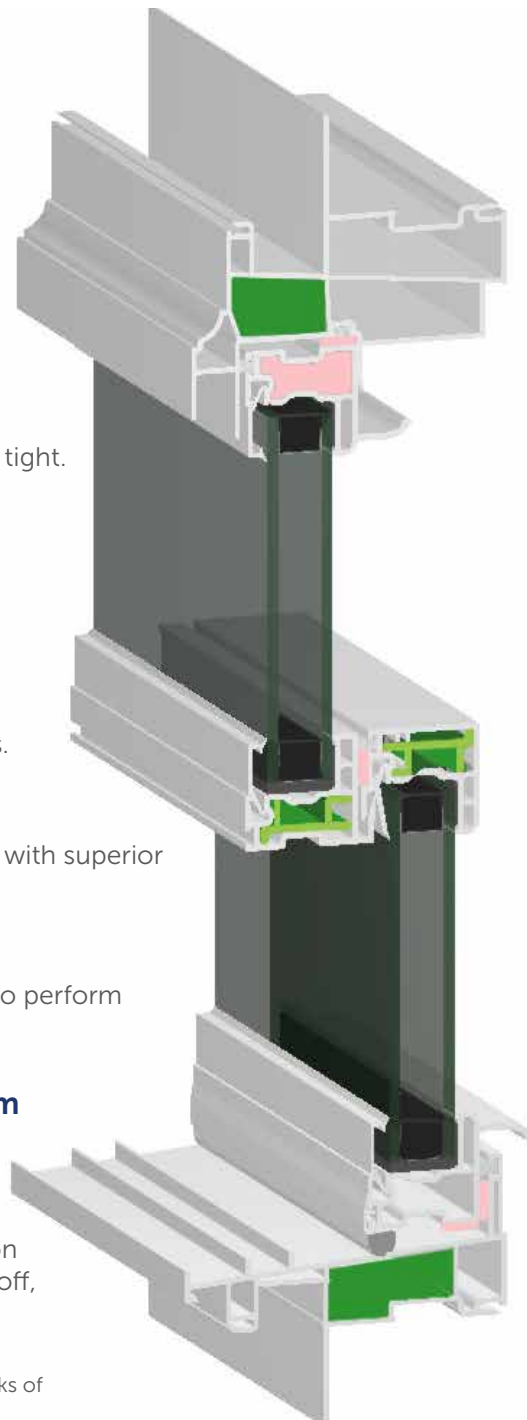

Foam Filled Frames

Provides thermal performance.

Owens Corning Weatherstripping

With AirSealing® technology. Laboratory tests prove up to 24% improvement versus other leading brands.



Superspacer Optimized Glass

Guaranteed not to fail utilizing Super Spacer Glass.

Balance Covers

Further reduce air infiltration while providing a crafted, finish.

Innergy® Thermal Reinforcement

In meeting rail provides metal-like stiffness without the thermal conductivity.

Insulated Low-E Argon Glass

U value = .27

Stainless Steel Constant Force Balance

Trouble-free, and maintenance-free while providing smooth operation as well as safe and easy cleaning.

Extruded Half Screen

Stronger frame is less likely to bend like roll form material.

The Power of Options

Make your home as unique as you are, with customizable window options. From colors to finishes, to handles and more, you have the power to choose from endless features. Take a look at what we have to offer!

GRILL OPTIONS

RJT provides a range of exterior options and capabilities to make your windows a beautiful feature of your home.

SCREEN OPTIONS

Half screen • Full screen

GLASS OPTIONS

Tempered • Obscured • Tinted • ACG Comfortec 28

INTERIOR GRILLES & DIVIDERS



SOLID INTERIOR COLORS



Colonial Grid Patterns

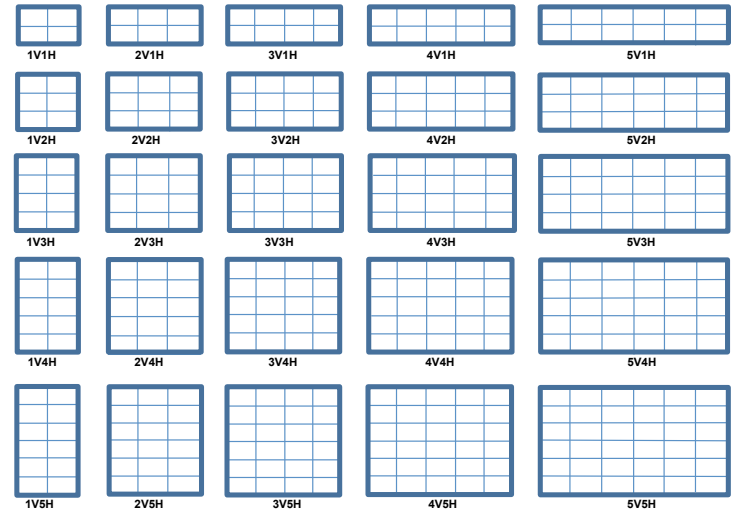

EXTERIOR COLORS

TruBond polyurethane color coating • Can be mixed or matched to your desired color.



Attention to detail ensures you a long-term investment, high performance, beauty and security.

Congratulations for choosing RJT Industries.

Custom made right here in Virginia for your home.

RJT industries
manufacturing quality windows for over 40 years

Best investment: Recoup up to 74% of cost when customer sells home.
(Remodeling magazine, January 2016)

14893 Persistence Drive
Woodbridge, Virginia 22191